

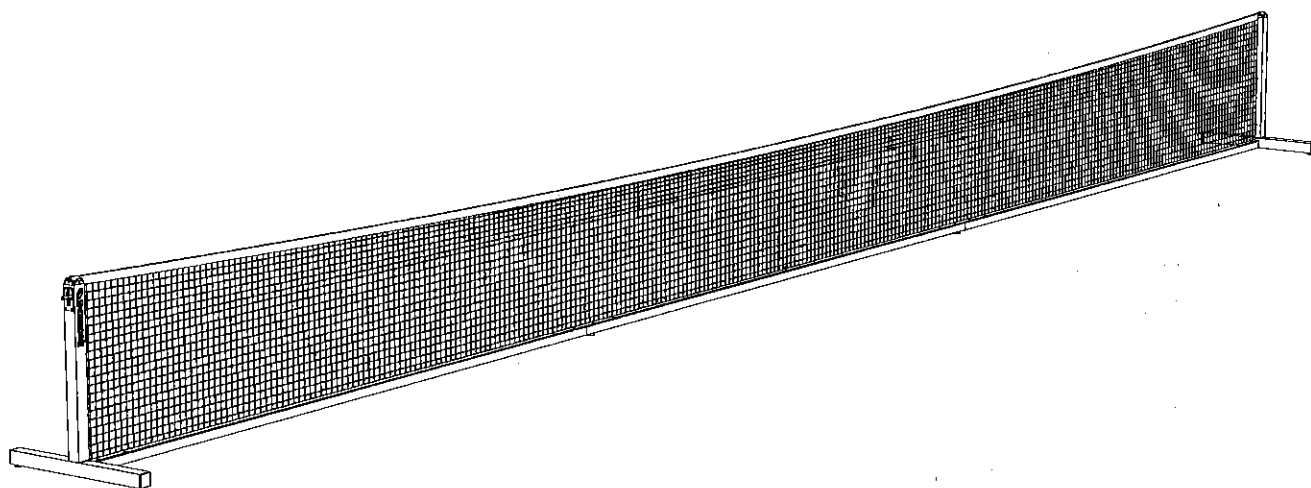

TEN-100

Freestanding Tennis Posts



A minimum of 1 person is required for this assembly
Estimated 30 minutes assembly time.



WARNING: Do **not** over tension tennis net. Doing so may cause damage to both the posts and court surface.



IMPORTANT: TEN-002: P17 Polythene Tennis Net Sold Separately.



IMPORTANT: Please read these assembly instructions carefully before starting to assemble your tennis posts.

Pack Contents

Freestanding Tennis Posts

1. Winder Post
2. Dummy Post
3. Centre Bar
4. End Bar
5. Connector Channel

Optional Extras
TEN-081 T4 Adjuster Set

Tools Required

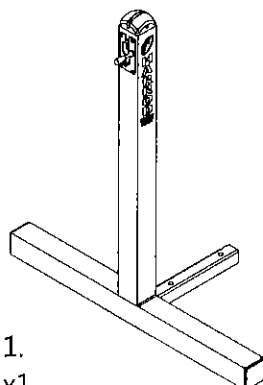
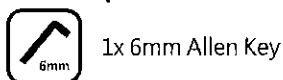

1.
x1
FEP807

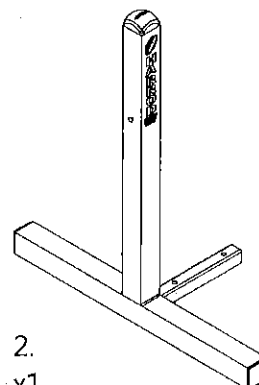

2.
x1
FEP808

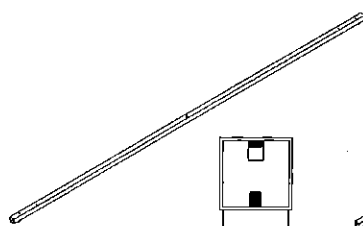

3.
x1
FEP811

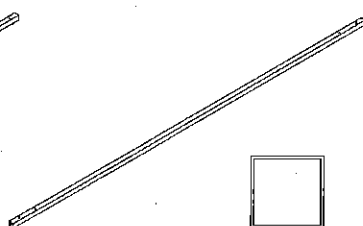

4.
x2
PEP812

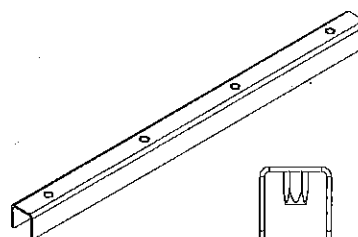

5.
x2
FEP807/808

Fittings Pack Contents

FPK915: Freestanding Tennis Fittings

6. M5 Post Hook
7. M6 Eyebolt
8. M10x25mm Set Screw
9. M10 Washer

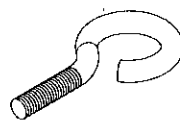

6.
x6
HKS022

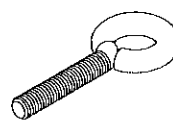

7.
x1
BOL612

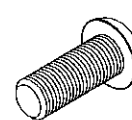

8.
x12
BOL351

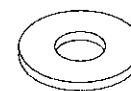



9.
x12
BOL709

*parts are not to scale

Assembly Instructions

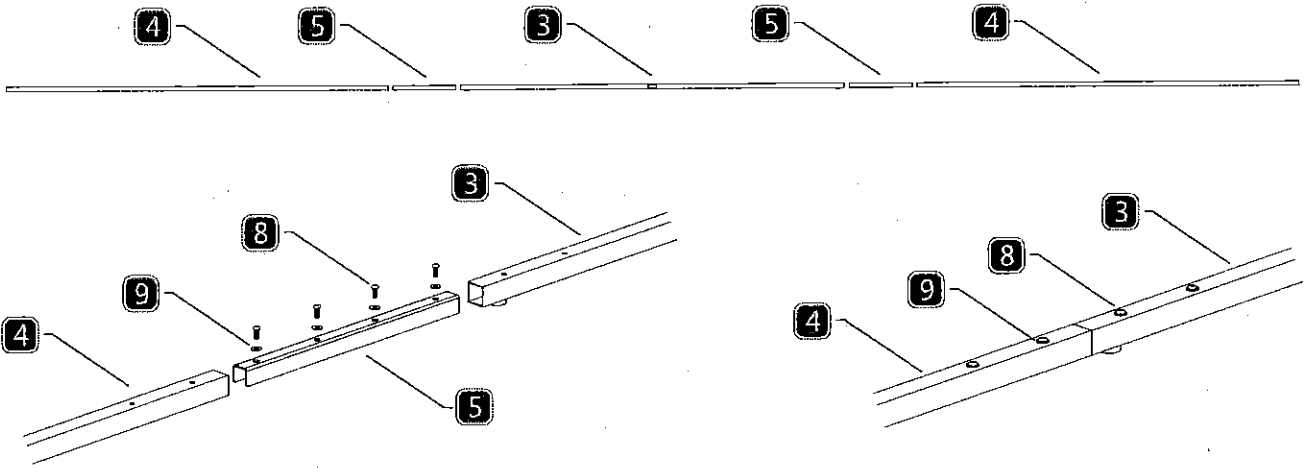
-  **1** Insert the Connector Channels (5) into the Centre Bar (3) and secure using two M10x25mm Set Screws (8) and two M10 Washers (9) each end. Slide the End Bars (4) over the Connector Channel and secure using two M10x25mm Set Screws and two M10 Washers.



-  **2** Insert the channel on the Dummy Post (2) into the End Bar and secure with two M10x25mm Set Screws and two M10 Washers. Repeat for the Winder Post (1).

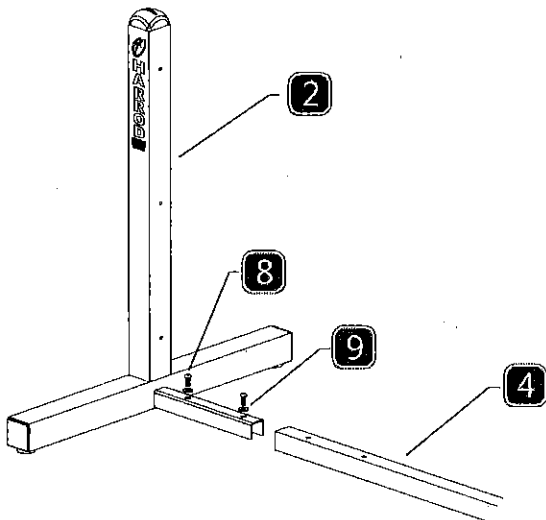

- 3** Insert the M6 Eyebolt (7) into the rivnut in the Centre Bar.

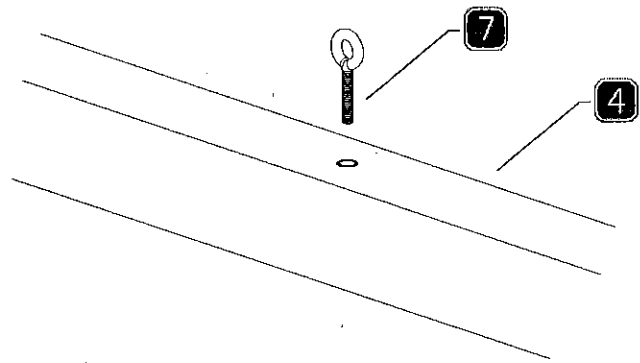

- 4** Screw three M5 Post Hooks (6) into the tapped holes on the inside of each upright.

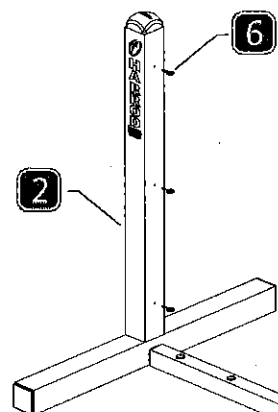

Attaching the Net

- 1 Wrap the loop end of the net headline around the stud on the Dummy Post.

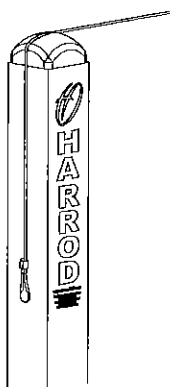

- 2 Thread the blank end of the headline through the top of the Winder Post, behind the brass pulley. Insert the blank end into the hole in the winder drum.

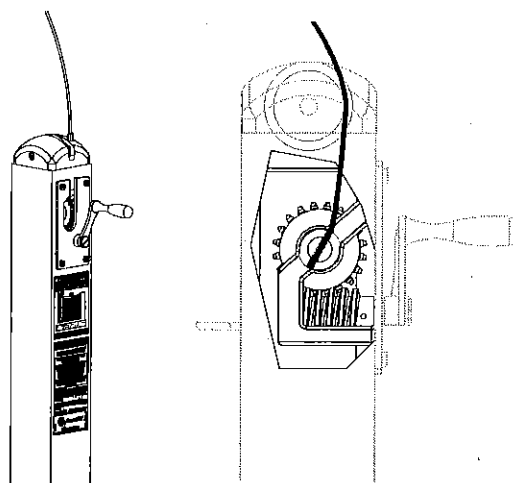

- 3 Hook each end of the net onto the hooks on each post.

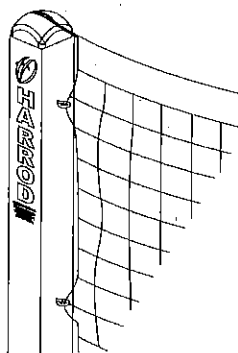

- 4 Using the brass winder, tension the net in accordance with the laws of the game.



WARNING: Do **not** over tension tennis net. Doing so may cause damage to both the posts and court surface.

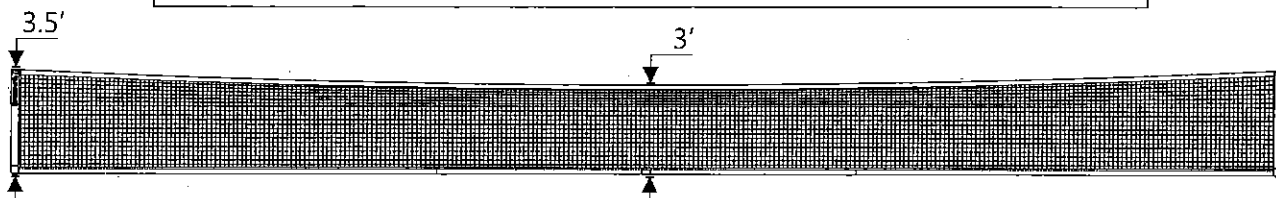

Optional Extras

TEN-081: T4 Adjuster Set.

To fit the Adjuster Set, clip the band to the M6 Eyebolt in the centre bar. Wrap the band around the net and clip in place. Adjust the band, ensuring the net achieves regulation height without over tensioning the posts.